









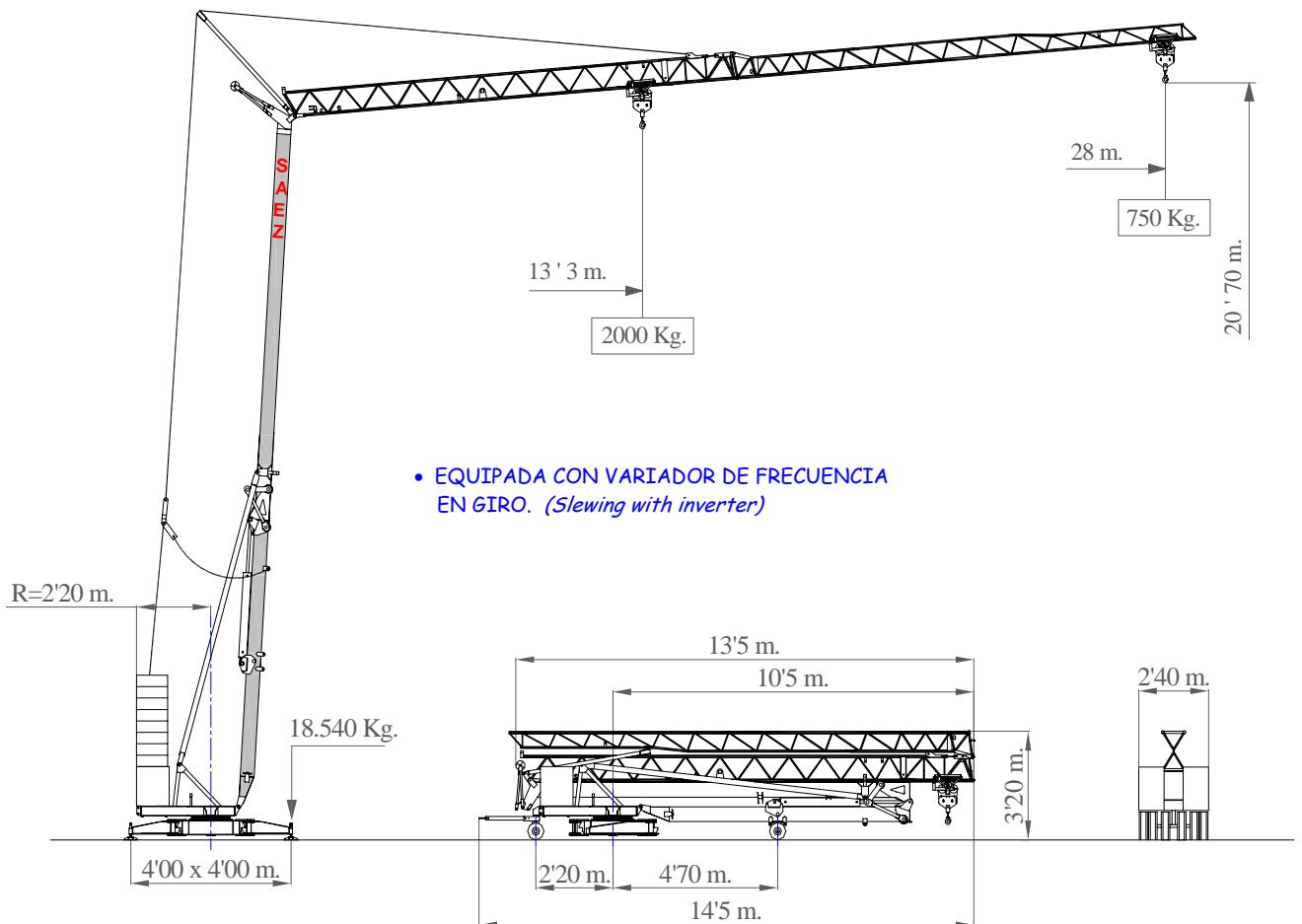
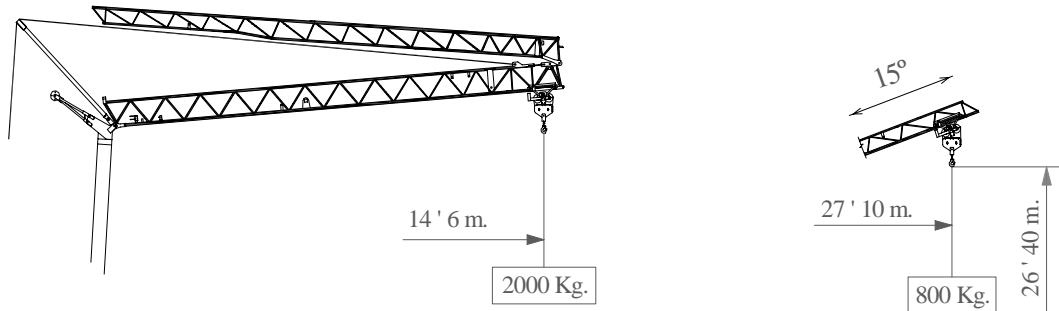

H-28

-  Grúa hidráulica
-  Crane hydraulic
-  Hydraulischer kran
-  Grue hydraulique
-  Gru hidráulica







- EQUIPADA CON VARIADOR DE FRECUENCIA EN GIRO. (*Slewing with inverter*)

MECANISMOS / Mechanisms / Antriebe / Mécanismes / Meccanismi

				
	m/min	5	20'5	41
	Kg	2000	2000	1000
	Kw	1'8	7'5	7'5
	m/min	18'5		37
	Kg	2000		2000
	Kw	0'75		1'5
	r.p.m	0'25	0'5	0'8
	N.m	30		
	Kw	4		

ALIMENTACION ELECTRICA Mains supply Netzstrom Réseau électrique Alimentazione elettrica	400 V 50 Hz
-----------------------------------------------------------------------------------------------------	----------------

POTENCIA ELECTRICA NECESARIA Power requirement Anschlusswert Puissance électrique nécessaire Potenza elettrica necessaria	13 Kw
---------------------------------------------------------------------------------------------------------------------------------------	-------

-  Elevación / Hoisting / Heben / Levage / Sollevamento
-  Distribución / Trolleying / Katzfahren / Distribution / Distributions
-  Orientación / Slewing / Schwenken / Orientation / Rotazione
-  Montaje / Erection / Montage / Montaggio

DIAGRAMAS DE CARGA / Loads diagrams / Lastkurven / Courbes de charges / Diagrammi di carico

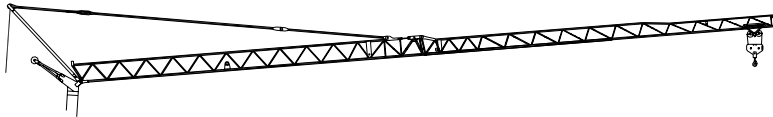

13'3	16	18	20	22	24	26	28	m
2000	1566	1341	1168	1031	920	827	750	Kg

PESO / Weight / Gewicht / Poids / Peso

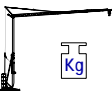
 8 x 1110 Kg + 2 x 2650 Kg	14 180 Kg	 10 500 Kg
------------------------------------------------------------------------------------------------------------------	-----------	-----------------------------------------------------------------------------------------------

MONTAJE / Erection / Montage / Montaggio

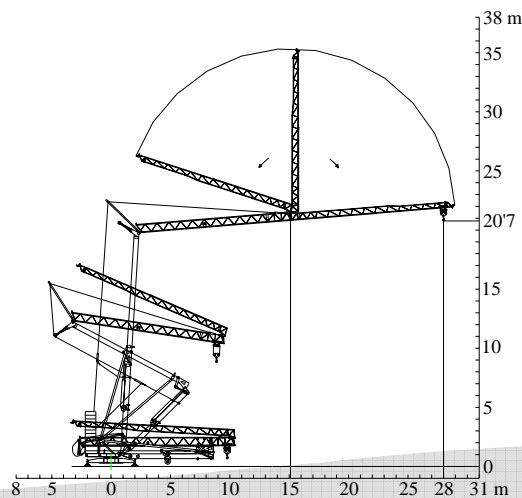

ESPECIFICACIONES SUJETAS A MODIFICACIONES SIN PREVIO AVISO.
Specifications subject to modification without notice.
Obiges kann ohne berstaendigung geaendert werden.
Specifications susceptibles de modification sans avis préalable.
Specifiche suscettibili di variazioni senza preavviso.

SISTEMAS FORZA, S.L.

Ctra. de Beniaján, Km. 5 • 30570, Beniaján – MURCIA (Spain)
Telf.: (+34) 968 83 70 81, Fax: (+34) 968 83 70 82